





NEWS



MARS
MAPLE p. 25

MARS

BIRCH

p. 27





SATURN

EVOLUTION

SO YOU THINK YOU KNOW SATURN? THINK AGAIN.

Saturn Evolution – the evolution of innovations

Maple / Walnut / Maple | Birch / Walnut / Birch | Hybrid combinations |
a brand new „HALO“ Mounting System | revolutionary Design Lab features
...the birth of **Saturn Evolution**.



Shell compositions

Two kinds of shell composition:

Saturn Maple: Maple/Walnut/Maple – Bright, Versatile, Open

Saturn Birch: Birch/Walnut/Birch – Dark, Punchy, Dry
Shell composition could be identified by badge on every component.

HALO Mounting System

The four diagonal supportive rubbers(contact points) on one-piece ring can release the pressure on shell more evenly, which makes shell have natural vibration and resonance.

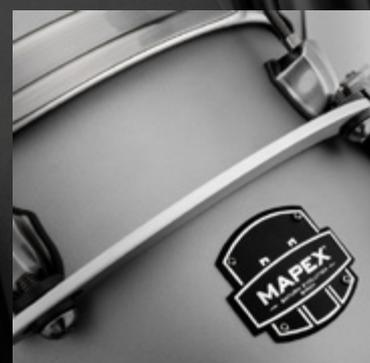

Chamber Specific Design

Plies get progressively thicker, depths graduate by 1/2", and bearing edges change, as the drums get larger in diameter. The combination of all of these details creates an amazing symphony in one kit, where each and every drum sounds perfect!



SAS Static 90° Floor Tom Leg

The straighter the path to the floor, the more sound loss: the static 90° Design Lab leg resolves this issue, allowing the most possible resonance from the floor toms.



SAS Sonic Pedestal Foot

The steel leg is prevented from contacting the ground by an internal cotter pin, allowing the floor tom to “float” on the elevated “spring” of the rubber foot, eliminating vibration transfer and maximizing resonance.



Floor Tom Isolation Gaskets

The metal components of the floor tom brackets are entirely on the outside of the shell, isolated by the special rubber lift gasket. This releases all pressure from the shell, alleviating vibration loss.



Air Flow Venting

The venting is key to the feel and the overall resonance of the shells. Through painstaking testing, each Chamber Specific approach has led to a formula of multiple vent holes in both Design Lab systems. Toms and bass drums have different combinations of vent holes. These air flow vents are placed at the Nodal line with the lugs, so as to not affect the resonance of the shells.



SAS Scale Finishes

SAS 0

Has little to no effect on the instruments' sound

SAS 1

Has a slight effect on the instruments' sound

SAS 2

Has a significant effect on the instruments' sound





SATURN

EVOLUTION |
EXOTIC FINISHES



EXOTIC AZURE BURST [PT]

Chrome Hardware

SAS 2

Finishes

+ **EXOTIC SUNBURST** [PO]

Chrome Hardware

SAS 2

+ **EXOTIC VIOLET BURST** [BPZ]

Black Brushed Hardware

SAS 2



SHELL CONSTRUCTION

Maple / Walnut / Exotic Maple
 9 ply 7.85 mm (TT 8-10")
 9 ply 8.55 mm (TT/FT 12-16")
 9 ply 9.25 mm (BD/GD 18-24")

Birch / Walnut / Exotic Birch
 7 ply 6.15 mm (TT 8-10")
 7 ply 6.85 mm (TT/FT 12-16")
 9 ply 8.55 mm (BD/GD 18-24")

Saturn Evolution | Exotic Finishes

MXSE628X Studioease Shell Set

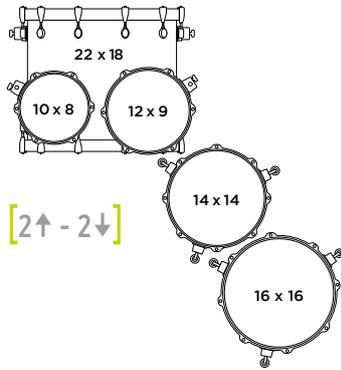

MXSE504X Jazz Shell Set

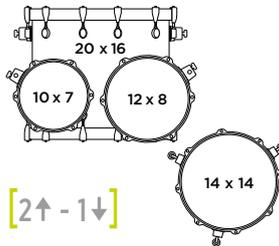

MXSE529X Rock Shell Set

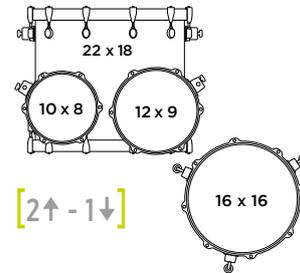

MXSE529XE Rock Shell Set (Fast Sizes)

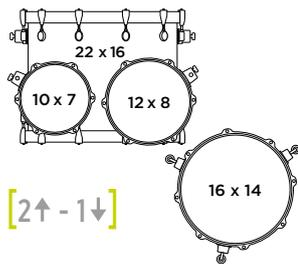

MXSE401XH Jazz Shell Set

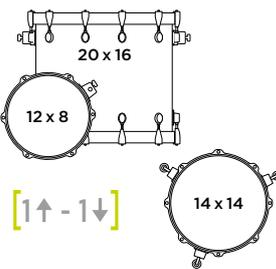

MXSE426XH Rock Shell Set

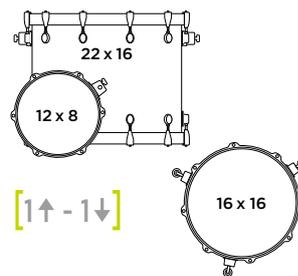

MXSE446XH Rock Shell Set

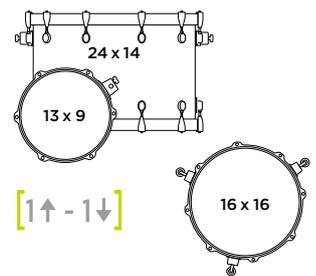

Available finishes:



Shell Sets

Order-No.	Description	Dealer Net €	SRP €
MXSE628X	Shell Set, Maple (M) or Birch (B), consisting of: BD 22x18", TT 10x8", TT 12x9", FT 14x14", FT 16x16", 2x Tom holder TH800	2.642,05	3.399,00
MXSE504X	Shell Set, Maple (M) or Birch (B), consisting of: BD 20x16", TT 10x7", TT 12x8", FT 14x14", 2x Tom holder TH800	2.253,40	2.899,00
MXSE529X	Shell Set, Maple (M) or Birch (B), consisting of: BD 22x18", TT 10x8", TT 12x9", FT 16x16", 2x Tom holder TH800	2.253,40	2.899,00
MXSE529XE	Shell Set, Maple (M) or Birch (B), consisting of: BD 22x16", TT 10x7", TT 12x8", FT 16x14", 2x Tom holder TH800	2.253,40	2.899,00
MXSE401XH	Hybrid Shell Set consisting of: BD 20x16" (Maple), TT 12x8" (Birch), FT 14x14" (Birch), 1x Tom holder TH800	1.864,75	2.399,00
MXSE426XH	Hybrid Shell Set consisting of: BD 22x16" (Maple), TT 12x8" (Birch), FT 16x16" (Birch), 1x Tom holder TH800	1.942,48	2.499,00
MXSE446XH	Hybrid Shell Set consisting of: BD 24x14" (Maple), TT 13x9" (Birch), FT 16x16" (Birch), 1x Tom holder TH800	2.074,62	2.669,00



ORDER NOTE

Shell Packs

Basic Order-No.		Wood <i>e.g. M = Maple</i>		Color code <i>e.g. PB = Piano Black</i>		Complete Order-No.
MXSE628X	+	M	+	PO	=	MXSE628XMPO

Single Drums

Basic Order-No.		Wood <i>e.g. M = Maple</i>		Color code <i>e.g. PB = Piano Black</i>		Complete Order-No.
MXSEB1814	+	M	+	PO	=	MXSEB1814MPO

Bass Drums

Single Drums

Order-No.	Description	Dealer Net €	SRP €
MXSEB1814	Bass Drum 18x14", w/o BD mount, Maple (M) or Birch (B)	931,99	1.199,00
MXSEB2016	Bass Drum 20x16", w/o BD mount, Maple (M) or Birch (B)	1.048,58	1.349,00
MXSEB2018	Bass Drum 20x18", w/o BD mount, Maple (M) or Birch (B)	1.048,58	1.349,00
MXSEB2216	Bass Drum 22x16", w/o BD mount, Maple (M) or Birch (B)	1.102,99	1.419,00
MXSEB2218	Bass Drum 22x18", w/o BD mount, Maple (M) or Birch (B)	1.102,99	1.419,00
MXSEB2414	Bass Drum 24x14", w/o BD mount, Maple (M) or Birch (B)	1.445,01	1.859,00
MXSEGB1816	Gong Bass Drum 18x16", Maple (M) or Birch (B)	931,99	1.199,00

Stand Toms

Order-No.	Description	Dealer Net €	SRP €
MXSEF1412	Floor Tom 14x12", Maple (M) or Birch (B)	512,24	659,00
MXSEF1414	Floor Tom 14x14", Maple (M) or Birch (B)	512,24	659,00
MXSEF1614	Floor Tom 16x14", Maple (M) or Birch (B)	535,56	689,00
MXSEF1616	Floor Tom 16x16", Maple (M) or Birch (B)	535,56	689,00
MXSEF1816	Floor Tom 18x16", Maple (M) or Birch (B)	574,43	739,00

Tom Toms

Order-No.	Description	Dealer Net €	SRP €
MXSET807	Tom Tom 8x7", Maple (M) or Birch (B)	271,28	349,00
MXSET1007	Tom Tom 10x7", Maple (M) or Birch (B)	302,37	389,00
MXSET1008	Tom Tom 10x8", Maple (M) or Birch (B)	302,37	389,00
MXSET1208	Tom Tom 12x8", Maple (M) or Birch (B)	317,92	409,00
MXSET1209	Tom Tom 12x9", Maple (M) or Birch (B)	317,92	409,00
MXSET1309	Tom Tom 13x9", Maple (M) or Birch (B)	372,33	479,00
MXSET1310	Tom Tom 13x10", Maple (M) or Birch (B)	372,33	479,00



SATURN

EVOLUTION | STANDARD FINISHES



 **IRIDIUM SILVER** [PD]
Chrome Hardware

SAS 0



 **TUSCAN YELLOW** [PM]
Chrome Hardware

SAS 0



 **TUSCAN RED** [BPA]
Black Brushed Hardware

SAS 0

Finishes



BRUNSWICK GREEN [PQ]

Chrome Hardware

SAS 1



PIANO BLACK [PB]

Chrome Hardware

SAS 1



GUN METAL GREY [BPG]

Black Brushed Hardware

SAS 0



POLAR WHITE [BPI]

Black Brushed Hardware

SAS 1

Saturn Evolution | Standard Finishes



SHELL CONSTRUCTION

Maple / Walnut / Maple

8 ply 7.5 mm (TT 8-10")
8 ply 8.2 mm (TT/FT 12-16")
8 ply 8.9 mm (BD/GD 18-24")

Birch / Walnut / Birch

6 ply 5.8 mm (TT 8-10")
6 ply 6.5 mm (TT/FT 12-16")
8 ply 8.2 mm (BD/GD 18-24")

MXSE628X Studioease Shell Set

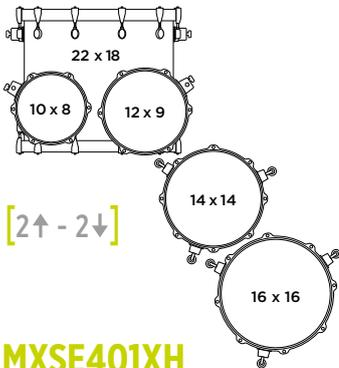

[2↑ - 2↓]

MXSE504X Jazz Shell Set

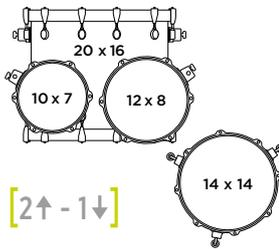

[2↑ - 1↓]

MXSE529X Rock Shell Set

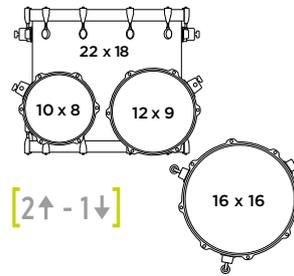

[2↑ - 1↓]

MXSE529XE Rock Shell Set (Fast Sizes)

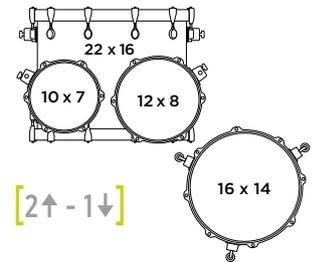

[2↑ - 1↓]

MXSE401XH Jazz Shell Set

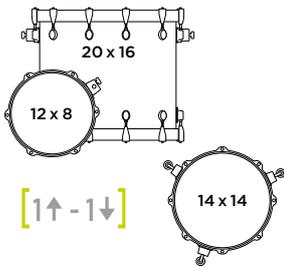

[1↑ - 1↓]

MXSE426XH Rock Shell Set

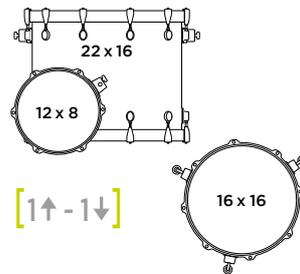

[1↑ - 1↓]

MXSE446XH Rock Shell Set

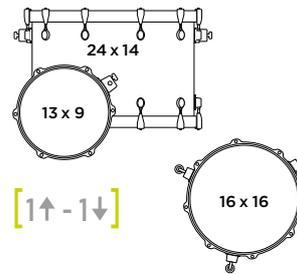

[1↑ - 1↓]



SAS 0

Iridium Silver (PD)
Chrome Hardware



SAS 0

Tuscan Yellow (PM)
Chrome Hardware

Available finishes:



SAS 1

Brunswick Green (PQ)
Chrome Hardware



SAS 1

Piano Black (PB)
Chrome Hardware



SAS 0

Tuscan Red (BPA)
Black Brushed Hardware



SAS 0

Gun Metal Grey (BPG)
Black Brushed Hardware



SAS 1

Polar White (BPI)
Black Brushed Hardware

Shell Sets

Order-No.	Description	Dealer Net €	SRP €
MXSE628X	Shell Set, Maple (M) or Birch (B), consisting of: BD 22x18", TT 10x8", TT 12x9", FT 14x14", FT 16x16", 2x Tom holder TH800	2.408,86	3.099,00
MXSE504X	Shell Set, Maple (M) or Birch (B), consisting of: BD 20x16", TT 10x7", TT 12x8", FT 14x14", 2x Tom holder TH800	2.020,21	2.599,00
MXSE529X	Shell Set, Maple (M) or Birch (B), consisting of: BD 22x18", TT 10x8", TT 12x9", FT 16x16", 2x Tom holder TH800	2.020,21	2.599,00
MXSE529XE	Shell Set, Maple (M) or Birch (B), consisting of: BD 22x16", TT 10x7", TT 12x8", FT 16x14", 2x Tom holder TH800	2.020,21	2.599,00
MXSE401XH	Hybrid Shell Set consisting of: BD 20x16" (Maple), TT 12x8" (Birch), FT 14x14" (Birch), 1x Tom holder TH800	1.678,20	2.159,00
MXSE426XH	Hybrid Shell Set consisting of: BD 22x16" (Maple), TT 12x8" (Birch), FT 16x16" (Birch), 1x Tom holder TH800	1.748,15	2.249,00
MXSE446XH	Hybrid Shell Set consisting of: BD 24x14" (Maple), TT 13x9" (Birch), FT 16x16" (Birch), 1x Tom holder TH800	1.856,98	2.389,00



ORDER NOTE

Shell Packs

Basic Order-No.		Wood		Color code		Complete Order-No.
		<i>e.g. M = Maple</i>		<i>e.g. PB = Piano Black</i>		
MXSE628X	+	M	+	PB	=	MXSE628XMPB

Single Drums

Basic Order-No.		Wood		Color code		Complete Order-No.
		<i>e.g. M = Maple</i>		<i>e.g. PB = Piano Black</i>		
MXSEB1814	+	M	+	PB	=	MXSEB1814MPB

Bass Drums

Single Drums

Order-No.	Description	Dealer Net €	SRP €
MXSEB1814	Bass Drum 18x14", w/o BD mount, Maple (M) or Birch (B)	807,62	1.039,00
MXSEB2016	Bass Drum 20x16", w/o BD mount, Maple (M) or Birch (B)	908,67	1.169,00
MXSEB2018	Bass Drum 20x18", w/o BD mount, Maple (M) or Birch (B)	908,67	1.169,00
MXSEB2216	Bass Drum 22x16", w/o BD mount, Maple (M) or Birch (B)	955,31	1.229,00
MXSEB2218	Bass Drum 22x18", w/o BD mount, Maple (M) or Birch (B)	955,31	1.229,00
MXSEB2414	Bass Drum 24x14", w/o BD mount, Maple (M) or Birch (B)	1.305,09	1.679,00
MXSEGB1816	Gong Bass Drum 18x16", Maple (M) or Birch (B)	807,62	1.039,00

Stand Toms

Order-No.	Description	Dealer Net €	SRP €
MXSEF1412	Floor Tom 14x12", Maple (M) or Birch (B)	465,60	599,00
MXSEF1414	Floor Tom 14x14", Maple (M) or Birch (B)	465,60	599,00
MXSEF1614	Floor Tom 16x14", Maple (M) or Birch (B)	488,92	629,00
MXSEF1616	Floor Tom 16x16", Maple (M) or Birch (B)	488,92	629,00
MXSEF1816	Floor Tom 18x16", Maple (M) or Birch (B)	527,79	679,00

Tom Toms

Order-No.	Description	Dealer Net €	SRP €
MXSET807	Tom Tom 8x7", Maple (M) or Birch (B)	247,96	319,00
MXSET1007	Tom Tom 10x7", Maple (M) or Birch (B)	279,05	359,00
MXSET1008	Tom Tom 10x8", Maple (M) or Birch (B)	279,05	359,00
MXSET1208	Tom Tom 12x8", Maple (M) or Birch (B)	294,60	379,00
MXSET1209	Tom Tom 12x9", Maple (M) or Birch (B)	294,60	379,00
MXSET1309	Tom Tom 13x9", Maple (M) or Birch (B)	341,24	439,00
MXSET1310	Tom Tom 13x10", Maple (M) or Birch (B)	341,24	439,00



SATURN

SO YOU THINK YOU KNOW SATURN? THINK AGAIN.

Saturn – perpetuate the Classic!

The iconic sound of maple/walnut shelled drums collides with revolutionary Design Lab features, perpetuating the classic **Saturn Series!**



SAS Static 90° Floor Tom Leg

The straighter the path to the floor, the more sound loss: the static 90° Design Lab leg resolves this issue, allowing the most possible resonance from the floor toms.

SAS Sonic Pedestal Foot

The steel leg is prevented from contacting the ground by an internal cotter pin, allowing the floor tom to “float” on the elevated “spring” of the rubber foot, eliminating vibration transfer and maximizing resonance.





Floor Tom Isolation Gaskets

The metal components of the floor tom brackets are entirely on the outside of the shell, isolated by the special rubber lift gasket. This releases all pressure from the shell, alleviating vibration loss.

Air Flow Venting

The venting is key to the feel and the overall resonance of the shells. Through painstaking testing, each Chamber Specific approach has led to a formula of multiple vent holes in both Design Lab systems. Toms and bass drums have different combinations of vent holes. These air flow vents are placed at the Nodal line with the lugs, so as to not affect the resonance of the shells.



SAS Scale Finishes

SAS 0

Has little to no effect on the instruments' sound

SAS 1

Has a slight effect on the instruments' sound





SATURN SERIES

⊕ SATIN BLACK [FB]

SAS 0

⊕ TEAL BLUE FADE [RJ]

SAS 1

⊕ SCARLET FADE [RQ]

SAS 1



Finishes

+ SATIN WHITE [RM]

SAS 0

+ AQUA FADE [UQ]

SAS 1

+ SULPHUR FADE [UJ]

SAS 1

Saturn Series



SHELL CONSTRUCTION

Walnut / Maple / Maple
 6 ply 5.8 mm (TT/FT 12-16")
 6 ply 7.2 mm (BD/GD 18-24")

MXSR628X Studioease Shell Set

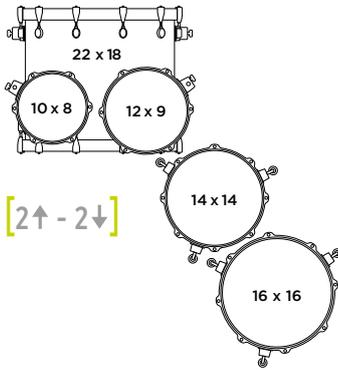

MXSR628XU Studioease Shell Set

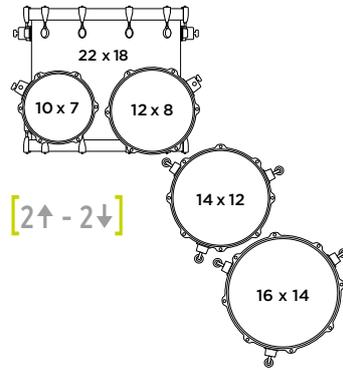

MXSR529X Rock Shell Set

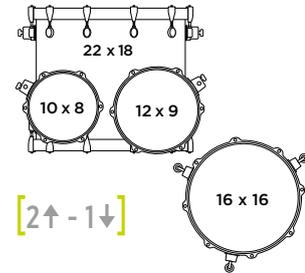

Available finishes:



MXSR529XU Rock Shell Set (Fast Sizes)

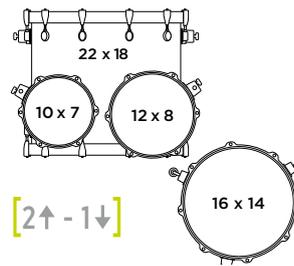

MXSR504X Jazz Shell Set

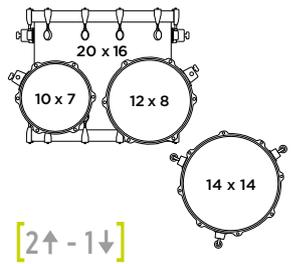

Shell Sets

Order-No.	Description	Dealer Net €	SRP €
MXSR628X	Shell Set consisting of: BD 22x18", TT 10x8", TT 12x9", FT 14x14", FT 16x16", 2x Tom holder TH800	1.787,02	2.299,00
MXSR628XU	Shell Set consisting of: BD 22x18", TT 10x7", TT 12x8", FT 14x12", FT 16x14", 2x Tom holder TH800	1.787,02	2.299,00
MXSR529X	Shell Set consisting of: BD 22x18", TT 10x8", TT 12x9", FT 16x16", 2x Tom holder TH800	1.476,10	1.899,00
MXSR529XU	Shell Set consisting of: BD 22x18", TT 10x7", TT 12x8", FT 16x14", 2x Tom holder TH800	1.476,10	1.899,00
MXSR504X	Shell Set consisting of: BD 20x16", TT 10x7", TT 12x8", FT 14x14", 2x Tom holder TH800	1.476,10	1.899,00

i The Saturn series is available with Chrome fittings only.



TUNE LESS
PLAY MORE
 WITH SONICLEAR™ BEARING EDGE

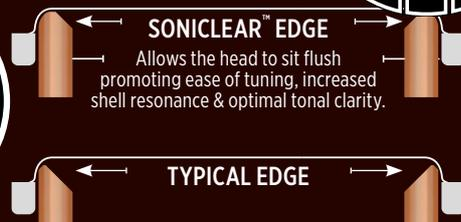

Bass Drums

Single Drums

Order-No.	Description	Dealer Net €	SRP €
MXSRB1814A	Bass Drum 18x14", w/o BD mount	644,38	829,00
MXSRB2016A	Bass Drum 20x16", w/o BD mount	729,89	939,00
MXSRB2018A	Bass Drum 20x18", w/o BD mount	729,89	939,00
MXSRB2216A	Bass Drum 22x16", w/o BD mount	760,98	979,00
MXSRB2218A	Bass Drum 22x18", w/o BD mount	760,98	979,00
MXSRB2414A	Bass Drum 24x14", w/o BD mount	838,71	1.079,00
MXSRGB1816	Gong Bass Drum 18x16"	644,38	829,00

Stand Toms

Order-No.	Description	Dealer Net €	SRP €
MXSRF1412	Floor Tom 14x12"	372,33	479,00
MXSRF1414	Floor Tom 14x14"	372,33	479,00
MXSRF1614	Floor Tom 16x14"	387,87	499,00
MXSRF1616	Floor Tom 16x16"	387,87	499,00
MXSRF1816	Floor Tom 18x16"	418,97	539,00

Tom Toms

Order-No.	Description	Dealer Net €	SRP €
MXSRT807	Tom Tom 8x7"	193,55	249,00
MXSRT1007	Tom Tom 10x7"	224,64	289,00
MXSRT1008	Tom Tom 10x8"	224,64	289,00
MXSRT1208	Tom Tom 12x8"	232,41	299,00
MXSRT1209	Tom Tom 12x9"	232,41	299,00
MXSRT1309	Tom Tom 13x9"	271,28	349,00
MXSRT1310	Tom Tom 13x10"	271,28	349,00

Snares

Order-No.	Description	Dealer Net €	SRP €
MXSRS4650	Snare 14x6.5"	349,01	449,00



ARMORY SERIES



⊕ NIGHT SKY BURST [CVL]



⊕ RAINFOREST BURST [CET]



⊕ EMERALD BURST [CFG]

Finishes



+ BLACK DAWN [CTK]



+ DESERT DUNE [DW]



+ ULTRAMARINE [CUM]



+ REDWOOD BURST [CRA]

Armory Series



SHELL CONSTRUCTION

Birch / Maple / Birch Hybrid
7.2 mm, 6 ply
laquered

MXAR628F Studioease Shell Set

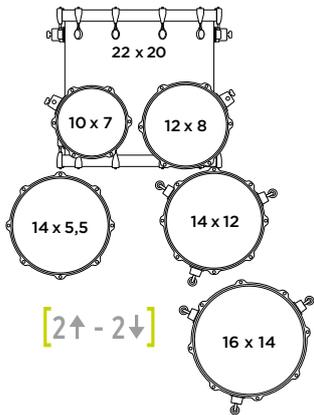

MXAR628S Studioease Shell Set

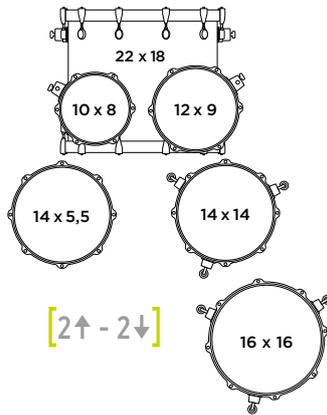

MXAR529S Rock Shell Set

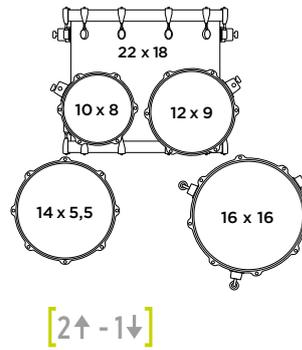

MXAR504S Jazz Shell Set

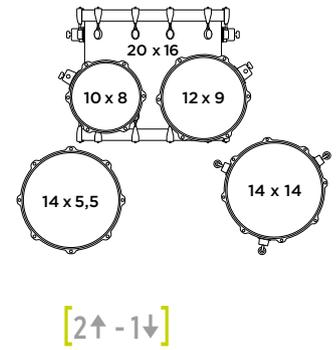

Available finishes:

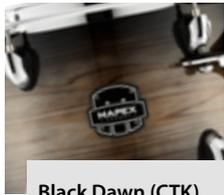
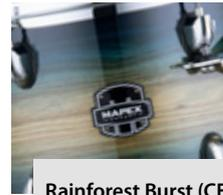

Shell Sets

Order-No.	Description	Dealer Net €	SRP €
MXAR628F	Shell Set consisting of: BD 22x20" (w/o BD mount), TT 10x7", TT 12x8", FT 14x12", FT 16x14", ARMORY Tomahawk 14x5.5" Steel Snare, Tom holder TH800	1.149,63	1.479,00
MXAR628S	Shell Set consisting of: BD 22x18" (w/o BD mount), TT 10x8", TT 12x9", FT 14x14", FT 16x16", ARMORY Tomahawk 14x5.5" Steel Snare, Tom holder TH800	1.149,63	1.479,00
MXAR529S	Shell Set consisting of: BD 22x18" (w/o BD mount), TT 10x8", TT 12x9", FT 16x16", ARMORY Tomahawk 14x5.5" Steel Snare, Tom holder TH800	963,08	1.239,00
MXAR504S	Shell Set consisting of: BD 20x16" (w/o BD mount), TT 10x8", TT 12x9", FT 14x14", ARMORY Tomahawk 14x5.5" Steel Snare, Tom holder TH800	963,08	1.239,00

i The Armory series is available with Chrome fittings only.



TUNE LESS
PLAY MORE
WITH SONICLEAR™ BEARING EDGE

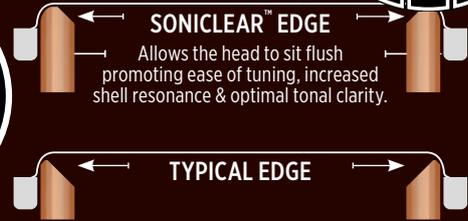



NEW

MARS

MAPLE

Finishes



MATTE BLACK [KD]



NATURAL SATIN [NW]



MIDNIGHT BLUE [OD]



GLOSSY AMBER [OG]



SHELL CONSTRUCTION

Maple

100% European Maple 7 ply,
7,2mm

FEATURES

SONIClear™ Bearing Edge
SONIClear™ Suspension System
Insulated Bass Drum Claws
Matching Snare Drum
Bass Drum Mounted Tom Holders



MXMA486S:

Bass Drum Lifter included

MXMM628SFU Rock Shell Set

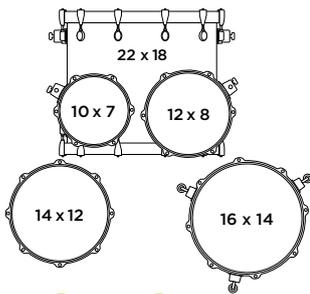

[2↑ - 1↓]

MXMM529SF Rock Shell Set

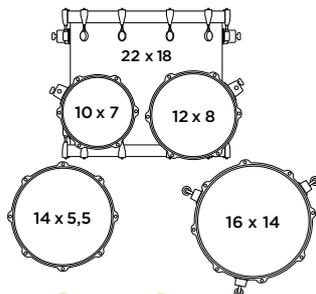

[2↑ - 1↓]

MXMM504SF Jazz Shell Set

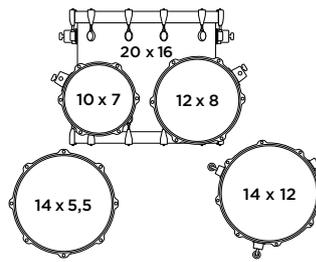

[2↑ - 1↓]

MXMM486S Rock Shell Set

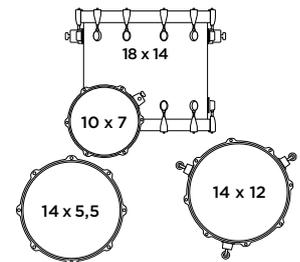

[1↑ - 1↓]

Available finishes:

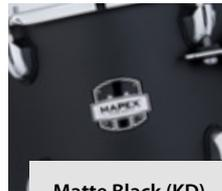

Matte Black (KD)



Natural Satin (NW)



Midnight Blue (OD)

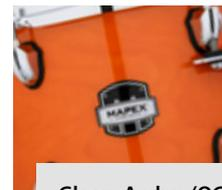

Glossy Amber (OG)

Shell Sets

	Order-No.	Description	Dealer Net €	SRP €
NEW	MXMM628SFU	Shell Set consisting of: BD 22x18", TT 10x7", TT 12x8", FT 14x12", FT 16x14", SD 14x5,5", Tomholder TH676	986,40	1.269,00
NEW	MXMM529SF	Shell Set consisting of: BD 22x18", TT 10x7", TT 12x8", FT 16x14", SD 14x5,5", Tomholder TH676	838,71	1.079,00
NEW	MXMM504SF	Shell Set consisting of: BD 20x16", TT 10x7", TT 12x8", FT 14x12", SD 14x5,5", Tomholder TH676	838,71	1.079,00
NEW	MXMM486S	Shell Set consisting of: BD 18x14", TT 10x7", FT 14x12", SD 14x5,5", Tomholder TH683 and Bass Drum Lifter MBL909	729,89	939,00

i The Mars series is available with Chrome fittings only.



NEW

MARS

BIRCH

Finishes



⊕ **DIAMOND SPARKLE [DT]**

⊕ **TWILIGHT SPARKLE [MI]**

⊕ **SUNFLOWER SPARKLE [YD]**

⊕ **BLOOD ORANGE SPARKLE [OR]**



SHELL CONSTRUCTION

Birch

100% Birch 6 ply, 7,2mm covered finishes

FEATURES

SONIClear™ Bearing Edge
SONIClear™ Suspension System
Matching Snare Drum

+ **MXMA486S:**
Bass Drum Lifter included

MXMA529SF Rock Shell Set

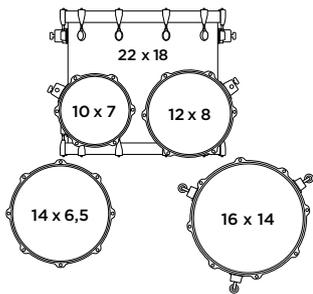

[2↑ - 1↓]

MXMA528SF Rock Shell Set

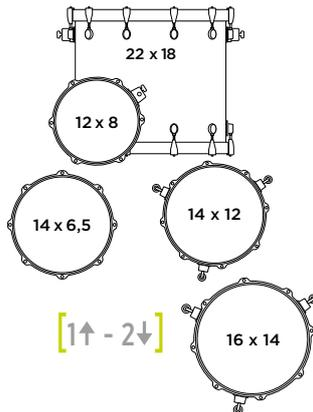

[1↑ - 2↓]

MXMA486S Jazz Shell Set

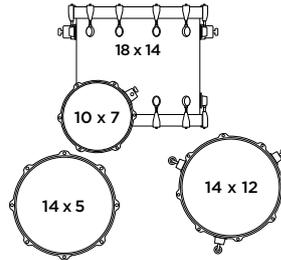

[1↑ - 1↓]

MXMA446S Rock Shell Set

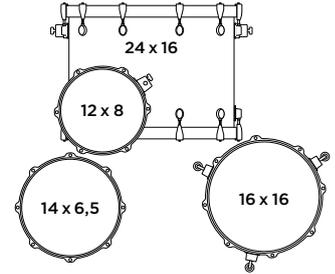

[1↑ - 1↓]

Available finishes:



Diamond Sparkle (DT)



Twilight Sparkle (MI)

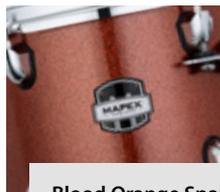

Blood Orange Sparkle (OR)



Sunflower Sparkle (YD)

Shell Sets

	Order-No.	Description	Dealer Net €	SRP €
NEW	MXMA529SF	Shell Set consisting of: BD 22x18", TT 10x7", TT 12x8", FT 16x14", SD 14x6.5", Tom holder TH676	675,48	869,00
NEW	MXMA528SF	Shell Set consisting of: BD 22x18" (w/o BD mount), TT 12x8", FT 14x12", FT 16x14", SD 14x6.5", Tom holder TH800	683,25	879,00
NEW	MXMA486S	Shell Set consisting of: BD 18x14", TT 10x7", FT 14x12", SD 14x5", Tom Holder TH683, 6705-075A and Bass Drum Lifter MBL909	621,06	799,00
NEW	MXMA446S	Shell Set consisting of: BD 24x16" (w/o BD mount), TT 12x8", FT 16x16", SD 14x6.5", Tom holder TH800	683,25	879,00

i The Mars series is available with Chrome fittings only.



VENUS

SERIES



+ STEEL BLUE METALLIC [VC]



+ BLACK GALAXY SPARKLE [VH]



+ BLUE SKY SPARKLE [VI]

Finishes



+ AQUA BLUE SPARKLE [VJ]



+ CRIMSON RED SPARKLE [VM]



+ COPPER METALLIC [VX]

Venus Series



SHELL CONSTRUCTION

Poplar
7,2mm, 9-ply
cover finishes

MXVE5045 Jazz Configuration

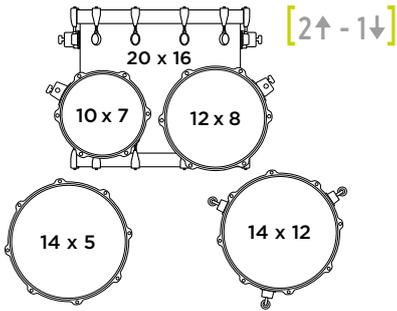

MXVE5295 Rock Configuration

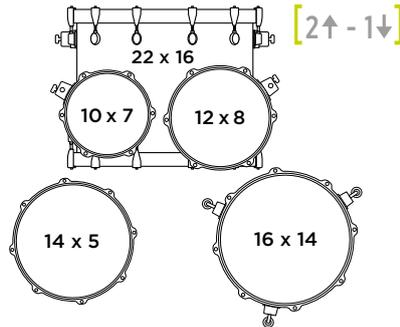

Available finishes:



Drum Sets

Order-No.	Description	Dealer Net €	SRP €
MXVE5045FTZ	Complete Drum Set consisting of: BD 20x16", TT 10x7", TT 12x8", FT 14x12", SN 14x5", B400, B200, S400, H410, P410, T400, Doubletomholder TH656 and Zildjian Planet Z Cymbal Set	779,89	999,00
MXVE5295FTZ	Complete Drum Set consisting of: BD 22x16", TT 10x7", TT 12x8", FT 16x14", SN 14x5", B400, B200, S400, H410, P410, T400, Doubletomholder TH656 and Zildjian Planet Z Cymbal Set	779,89	999,00

i The Venus series is available with Chrome fittings only.



The new Venus Series is provided as complete pack, including drum set, a complete hardwarepack, a ZILDJIAN Cymbal Pack plus Throne and Drumsticks. Furthermore, equipped with SONIClear™ Bearing Edge, the full tone of Venus makes you stand out from this price range.

**Practicing, listening, hearing, becoming ...
a Drummer For Life.**

Poplar Shell

9-Ply, 7.2mm Poplar shell offers a full, warm sound.

SONIClear™ Bearing Edge

Allows the head to sit flush prompting ease of tuning, increased shell resonance and optimal tonal clarity.

REMO® UC Drumheads

Drumhead is one of the key elements that impacts the sound. Venus is equipped with REMO® drumheads to ensure the pure tone can be delivered out from the shell.

Mini B-Lug

Inspired by the style of B lugs from Saturn Evolution Series.

TH652 Double Tom Holder

Simple functionality and multi-purpose adaptability.

Venus Series offers 6 exciting finishes to meet drummers' preference.





Tornado Series



SHELL CONSTRUCTION

9-ply Poplar
cover finishes

*** Configuration applies to Complete
Drumset and Pro Pack**

TND584*

Jazz Configuration

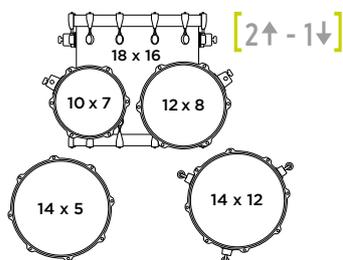

TND504*

Jazz Configuration

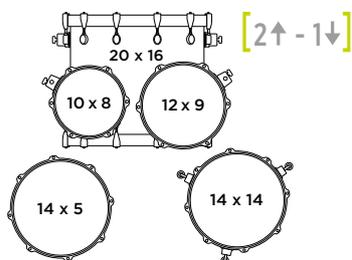

TND529*

Rock Configuration

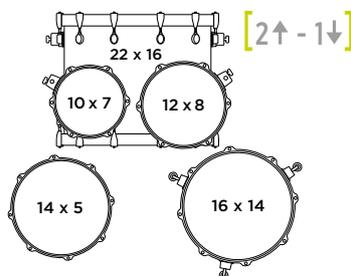

Additional finishes:



Dark Red (DR)



Royal Blue (YB)



**Configuration
TND5844FTC:
with extra low
Snare stand**

TND5044FTC in Dark Black (DK)

Complete Sets

Order-No.	Description	Dealer Net €	SRP €
TND5844FTC	Complete Drumset consisting of: BD 18x16", TT 10x7", TT 12x8", FT 14x12", SD 14x5" incl. 4-piece Hardware Pack, Throne, 14" Hats, 16" Crash	504,47	649,00
TND5044TC	Complete Drumset consisting of: BD 20x16", TT 10x8", TT 12x9", FT 14x14", SD 14x5" incl. 4-piece Hardware Pack, Throne, 14" Hats, 16" Crash	504,47	649,00
TND5294FTC	Complete Drumset consisting of: BD 22x16", TT 10x7", TT 12x8", FT 16x14", SD 14x5" incl. 4-piece Hardware Pack, Throne, 14" Hats, 16" Crash	504,47	649,00

i The Tornado series is available with Chrome fittings only.



TORNADO | Zildjian PRO PACK

Additional finishes:



Dark Black (DK)



Dark Red (DR)



Incl. **+**
MXB200TND

Incl. **+**
Zildjian Planet Z Complete Pack (14" HiHat, 16" Crash, 20" Ride)

TND5295TZ in Royal Blue (YB)

Order-No.	Description	Dealer Net €	SRP €
TND5845TZ	Pro Pack consisting of: BD 18x16", TT 10x7", TT 12x8", FT 14x12", SD 14x5" incl. 5-piece Hardware Pack, Throne, Zildjian Planet Z Cymbal Set	725,48	889,00
TND5045TZ	Pro Pack consisting of: BD 20x16", TT 10x8", TT 12x9", FT 14x14", SD 14x5" incl. 5-piece Hardware Pack, Throne, Zildjian Planet Z Cymbal Set	725,48	889,00
TND5295TZ	Pro Pack consisting of: BD 22x16", TT 10x7", TT 12x8", FT 16x14", SD 14x5" incl. 5-piece Hardware Pack, Throne, Zildjian Planet Z Cymbal Set	725,48	889,00

Percussion



Order-No.	Description	Dealer Net €	SRP €
MXMPK32PC	Glockenspiel with accessories and trolley	224,64	289,00
MXMSK14DC	Snare Kit with accessories and Trolley	185,78	239,00
MXMCK1432DP	Glockenspiel - 14x3.5" snare bundle with accessories and trolley	325,69	419,00



BLACK PANTHER designLAB

Ultra-Premium Snare Drums of the MAPEX Black Panther Design Lab

The MAPEX™ Black Panther Design Lab Series embodies the performance qualities desired by top players. These distinctive instruments have been engineered using the Design Lab's "Concept Hybrid" approach to sound design, shell composition and drum construction. Each drum has been designed to combine "Sound Concepts" to create unique and personal instruments for the demanding player.



BLACK PANTHER CHERRY BOMB

BPCW3550CNW - 13x5.5"
BPCW4600CNW - 14x6"



SHELL CONSTRUCTION

8 ply / 9 mm Cherry

BLACK PANTHER HEARTBREAKER



BPMH460LNW - 14x6"



SHELL CONSTRUCTION

8 ply 8 mm Mahogany
4 ply 4 mm Mahogany Reinforcement Rings



BLACK PANTHER EQUINOX

BPML4500CFB - 14x5"



SHELL CONSTRUCTION

6 ply 6 mm Maple / 4 ply 4 mm Maple Reinforcement Rings

Order-No.	Description	Dealer Net €	SRP €
BPCW3550CNW	Design Lab Snare, 13x5.5", Natural Satin Wood, „Cherry Bomb“	387,87	499,00
BPCW4600CNW	Design Lab Snare, 14x6", Natural Satin Wood, „Cherry Bomb“	387,87	499,00
BPMH460LNW	Design Lab Snare, 14x6", Natural Satin Wood, „Heartbreaker“	457,83	589,00
BPML4500CFB	Design Lab Snare, 14x5", Flat Black Maple Burl, „Equinox“	520,02	669,00

BLACK PANTHER
 design**LAB**
**ARTIST
SNARES**
The Versatus | Russ Miller
SHELL CONSTRUCTION

2.75 Maple
 1.7 *2-Mahogany
 2.4 Maple (8.55 mm)

 BPDLMH4460LPW **14 x 4.625"**

 BPDLMH4650LPW **14 x 6.5"**

The Maximus | Jeff Hamilton
SHELL CONSTRUCTION

2.4 Mahogany
 1.7 Mahogany
 2.4 *2-Mahogany
 (8.9 mm)

 BPDLMH4600LPB **14 x 6"**

**The Warbird |
Chris Adler**
SHELL CONSTRUCTION

1.7 Maple
 1.7 Walnut
 1.7 Walnut (5.1 mm)



BPDLMW2550LWH

12 x 5.5"

The Machine | Craig Blundell
SHELL CONSTRUCTION

1.7 Walnut | 2.4 Maple
 2.4 Maple (6.5 mm)

 BPDLMW4550LNW **14 x 5.5"**

Order-No.	Description	Dealer Net €	SRP €
BPDLMH4460LPW	Design Lab Artist Snare, 14x4.625", Maple/MahoganyMaple, Peach Burl Burst, „The Versatus“	675,48	869,00
BPDLMH4650LPW	Design Lab Artist Snare, 14x6.5", Maple/Mahogany/Maple, Peach Burl Burst, „The Versatus“	729,89	939,00
BPDLMH4600LPB	Design Lab Artist Snare, 14x6", Mahogany/Mahogany/Mahogany, Gloss Piano Black, „The Maximus“	729,89	939,00
BPDLMW4550LNW	Design Lab Artist Snare, 14x5.5", Walnut/Maple/Maple, Satin Natural over Walnut, „The Machine“	675,48	869,00
BPDLMW2550LWH	Design Lab Artist Snare, 12x5.5", Maple/Walnut/Walnut, Satin Natural over Walnut, „The Warbird“	605,52	779,00

BLACK PANTHER

WOOD



HYDRO 13x7"

BPNML3700LFB

SHELL CONSTRUCTION

6-ply 5.1 mm Maple | 4 ply 4 mm Walnut Enforcement Rings



NUCLEUS 14 x 5.5"

BPNMW4550CPB

SHELL CONSTRUCTION

8-ply 8.1 mm Maple/Walnut/Maple



RAZOR 14x5"

BPNML4500CGD

SHELL CONSTRUCTION

6-ply 6.0 mm Maple



PEGASUS 14x5.5"

BPBMW4550LXN

SHELL CONSTRUCTION

7-ply 6.15 mm Maple/Walnut



SHADOW 14x6.5"

BPNBW4650CXN

SHELL CONSTRUCTION

7-ply 6.85 mm Birch/Walnut



VENOM 14x5"

BPNML4550COW

SHELL CONSTRUCTION

8-ply 6.85 mm Maple



SOLIDUS 14x7"

BPNML4700CVD

SHELL CONSTRUCTION

11-ply, 11 mm Maple



HERITAGE 14x6"

BPNML4600CWD

SHELL CONSTRUCTION

5-ply 5.0 mm Maple | 4 ply 4 mm Walnut Enforcement Rings

Order-No.	Description	Dealer Net €	SRP €
BPNML3700LFB	Black Panther Snare 13x7", Maple/Walnut/Maple, Satin Black, „Hydro“	372,33	479,00
BPNMW4550CPB	Black Panther Snare 14x5.5", Maple/Walnut/Maple, Polished Black, „Nucleus“	349,01	449,00
BPNML4500CGD	Black Panther Snare 14x5", Maple, Dark Grey, „Razor“	294,60	379,00
BPBMW4550LXN	Black Panther Snare 14x5.5", Walnut/Maple, Natural Maple Burl, „Pegasus“	411,19	529,00
BPNBW4650CXN	Black Panther Snare 14x6.5", Birch/Walnut, Natural Maple Burl, „Shadow“	310,14	399,00
BPNML4550COW	Black Panther Snare 14x5", Maple, Arctic White, „Venom“	325,69	419,00
BPNML4700CVD	Black Panther Snare 14x7", Maple, Brown Red Burst, „Solidus“	411,19	529,00
BPNML4600CWD	Black Panther Snare 14x6", Maple, White Pricobloc Pearl, „Heritage“	279,05	359,00

SNARE PROGRAM

METAL



PERSUADER 14x6.5"

BPNBR465HCN

SHELL CONSTRUCTION
1.2 mm Hammered Brass



PREDATOR 14x6"

BPNCO4601CN

SHELL CONSTRUCTION
1.2 mm Copper



METALLION 14x5.5"

BPNBR4551CN

SHELL CONSTRUCTION
1.2 mm Brass



ATOMIZER 14x6.5"

BPNAL4651CN

SHELL CONSTRUCTION
2.0 mm Aluminum



CYRUS 14x6"

BPNST4601CN

SHELL CONSTRUCTION
1.0 mm Steel



WASP 10x5.5"

BPNST0551CN

SHELL CONSTRUCTION
1.0 mm Steel

Order-No.	Description	Dealer Net €	SRP €
BPNBR465HCN	Black Panther Snare 14x6.5", Hammered Brass, „Persuader“	465,60	599,00
BPNCO4601CN	Black Panther Snare 14x6", Copper, „Predator“	442,29	569,00
BPNBR4551CN	Black Panther Snare 14x5.5", Brass, „Metallion“	372,33	479,00
BPNAL4651CN	Black Panther Snare 14x6.5", Aluminum, „Atomizer“	442,29	569,00
BPNST4601CN	Black Panther Snare 14x6", Steel, „Cyrus“	302,37	389,00
BPNST0551CN	Black Panther Snare 10x5.5", Steel, „Wasp“	286,82	369,00

MPX Snare Drums



MXMPML36CNL



MXMPML45BMB

Maple

Order-No.	Description	Dealer Net €	SRP €
MXMPML36CNL	MPX Snare 13x6" Gloss Natural, Chrome	115,82	149,00
MXMPML45CNL	MPX Snare 14x5.5" Gloss Natural, Chrome	115,82	149,00
MXMPML45BMB	MPX Snare 14x5.5" Transp. Midnight Black, Black	115,82	149,00



MXMPST0554



MXMPST3354

Steel

Order-No.	Description	Dealer Net €	SRP €
MXMPST0554	MPX Snare 10x5.5" Sound Effect, Chrome	108,05	139,00
MXMPST3354	MPX Snare 13x3.5" Sound Effect, Chrome	108,05	139,00



MXMPBC45CXN



MXMPBC45BMB

Birch

Order-No.	Description	Dealer Net €	SRP €
MXMPBC45CXN	MPX Snare 14x5.5" Gloss Natural, Chrome	123,59	159,00
MXMPBC45BMB	MPX Snare 14x5.5" Transp. Midnight Black, Black	115,82	149,00

Hardware

ARMORY



Black Finish
(MXHP8005EB)

MARS



Black Finish
(MXHP8005EB)



MXHPF1000



MXHP2005TND

Hardware Packs

Order-No.	Description	Dealer Net €	SRP €
MXHPF1000	Falcon Hardware Pack, consisting of: 2x MXBF1000 Boom Stand, MXHF1000 Hihat Stand, MXSF1000 Snare Stand, MXP1000 Bass Drum Pedal, Chrome Finish	714,34	919,00
MXHP8005	Armory Hardware Pack, consisting of: 2x MXB800 Boom Stand, MXH800 Hihat Stand, MXS800 Snare Stand, MXP800 Bass Drum Pedal, Chrome Finish	457,83	589,00
MXHP8005EB	Armory Hardware Pack, consisting of: 2x MXB800 Boom Stand, MXH800 Hihat Stand, MXS800 Snare Stand, MXP800 Bass Drum Pedal, Black Finish	481,15	619,00
MXHP6005	Mars Hardware Pack, consisting of: 2x MXB600 Boom Stand, MXH600 Hihat Stand, MXS600 Snare Stand, MXP600 Bass Drum Pedal, Chrome Finish	325,69	419,00
MXHP6005EB	Mars Hardware Pack, consisting of: 2x MXB600 Boom Stand, MXH600 Hihat Stand, MXS600 Snare Stand, MXP600 Bass Drum Pedal, Black Finish	338,13	435,00
MXHP2005TND	Tornado Hardware Pack, consisting of: MXC200TND Cymbalstand, MXB200TND Boom Stand, MXH200TND Hihat Stand, MXS200TND Snare Stand, MXP200TND Bass Drum Pedal, Chrome Finish	154,68	199,00

Pedals

MXPF1000



MXPF1000TW



Order-No.	Description	Dealer Net €	SRP €
MXPF1000	Falcon, double chain, felt beater with exchangeable weight, base plate	216,87	279,00
MXPF1000TW	Falcon, double chain, felt beater with exchangeable weight, base plate	434,51	559,00
MXPF1000LTW	Falcon, double chain, felt beater with exchangeable weight, base plate, left version	434,51	559,00

MXP810



MXP810TW



Order-No.	Description	Dealer Net €	SRP €
MXP810	Armory, Response Drive, double chain, felt beater with exchangeable weight, base plate, incl. gigbag	136,03	175,00
MXP810TW	Armory, Response Drive, double chain, felt beater with exchangeable weight, base plate, incl. Gigbag	271,28	349,00

MXP600



MXP600TW



Order-No.	Description	Dealer Net €	SRP €
MXP600	Mars, double chain, felt beater, base plate	76,95	99,00
MXP600TW	Mars, double chain, felt beater, base plate	193,55	249,00

MXP410



MXP410TW



Order-No.	Description	Dealer Net €	SRP €
MXP410	Storm, single chain, Falcon Beater, base plate	58,30	75,00
MXP410TW	Storm, single chain, Falcon Beater, base plates	143,80	185,00

MXP200TND



Order-No.	Description	Dealer Net €	SRP €
MXP200TND	Tornado, single chain, felt beater	30,31	39,00



MXHF1000



MXH800



MXH600EB



MXH410



MXH410EB



MXH200TND

HiHats

Order-No.	Description	Dealer Net €	SRP €
MXHF1000	Falcon, Direct Pull Spring System, double braced, Chrome Finish	224,64	289,00
MXH800	Armory, Tru Direct Pull Drive System, double braced, rotating legs, Chrome finish	131,36	169,00
MXH800EB	Armory, Tru Direct Pull Drive System, double braced, rotating legs, Black Finish	139,14	179,00
MXH600	Mars, Direct Chain Drive, double braced, Chrome finish	97,16	125,00
MXH600EB	Mars, Direct Chain Drive, double braced, Black Finish	100,27	129,00
MXH410	Storm, Direct Chain Drive, double braced, Chrome Finish	76,95	99,00
MXH410EB	Storm, Direct Chain Drive, double braced, Black Finish	82,19	105,74
MXH200TND	Tornado, Direct Chain Drive, double braced, Chrome Finish	42,75	55,00



MXSF1000



MXS800EB



MXS600



MXS400



MXS400EB



MXS200TND

Snare Stands

Order-No.	Description	Dealer Net €	SRP €
MXSF1000	Falcon, extra low, steplessly adjustable, for 10-15" snares, Chrome Finish	112,71	145,00
MXS800	Armory, steplessly adjustable, double braced, Chrome Finish	76,95	99,00
MXS800EB	Armory, steplessly adjustable, double braced, Black Finish	81,62	105,00
MXS600	Mars, multi step tilter, double braced, Chrome Finish	66,07	85,00
MXS600EB	Mars, multi step tilter, double braced, Black Finish	69,18	89,00
MXS400	Storm, multi step tilter, double braced, Chrome Finish	53,63	69,00
MXS400EB	Storm, multi step tilter, double braced, Black Finish	58,30	75,00
MXS200TND	Tornado, multi step tilter, double braced, Chrome Finish	42,75	55,00

Drum Thrones



Order-No.	Description	Dealer Net €	SRP €
MXT875	Saddle seat, spindle, height 48-67 cm, with backrest	209,09	269,00
MXT870	Saddle seat, spindle, height 48-67 cm, with backrest	209,09	269,00
MXT865SER	Saddle seat, cloth top, red, spindle, height 46-66 cm	170,23	219,00
MXT865	Saddle seat, cloth top, spindle, height 46-66 cm	170,23	219,00
MXT855	Saddle seat, spindle, height 46-66 cm	159,35	205,00
MXT850	Saddle seat, spindle, height 46-66 cm	159,35	205,00
MXT675	Saddle seat, height adjustable, memory lock, height 41-62 cm	100,27	129,00
MXT670	round seat, height adjustable, memory lock, height 41-62 cm	76,95	99,00
MXT660	round seat, spindle, memory lock, height 41-62 cm	76,95	99,00
MXT400	Storm, round seat, 6-step with wing nut, height 44-56 cm	42,75	55,00
MXT270A	round seat, 6-step with wing nut, height 44-56 cm	58,30	75,00

Cymbal & Boom Stands



Order-No.	Description	Dealer Net €	SRP €
MXBF1000	Falcon, 2-step hide-away, one boom, Chrome Finish	128,25	165,00
MXB800	Armory, steplessly adjustable, retractable boom, double strut, Chrome Finish	92,50	119,00
MXB800EB	Armory, steplessly adjustable, retractable boom, double braced, Black Finish	97,16	125,00
MXB600	Mars, multi step tilter, retractable boom, double braced, Chrome Finish	69,18	89,00
MXB600EB	Mars, multi step tilter, retractable boom, double braced, Black Finish	69,18	89,00
MXB400	Storm, 2-step hide-away, one boom, Chrome Finish	53,63	69,00
MXB400EB	Storm, 2-step hide-away, one boom, Black Finish	58,30	75,00
MXC200TND	Tornado, straight, Chrome Finish	30,31	39,00
MXB200TND	Tornado, 1-step hide-away, one boom, Chrome Finish	34,98	45,00

Multi Stands

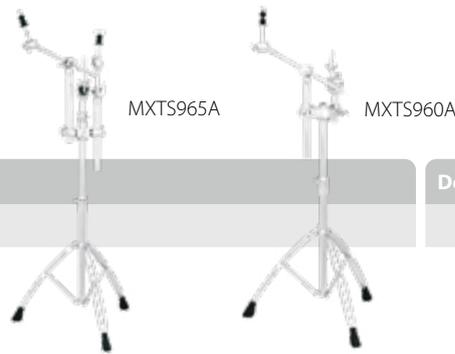

Order-No.	Description	Dealer Net €	SRP €
MXTS965A	1-step hide-away, with 1x TH684, 2x B75	224,64	289,00
MXTS960A	1-step hide-away, with 1x TH684, 1x B75	198,21	255,00

Tom Stands



Order-No.	Description	Dealer Net €	SRP €
MXTS950A	1-step hide-away, with 2x TH684	178,00	229,00
MXTS701	1-step hide-away, with 1x TH676	151,57	195,00

Cymbal Holder



Order-No.	Description	Dealer Net €	SRP €
MXB100	FALCON cymbal arm, tube diameter 7/8", Chrome Finish	69,18	89,00
MXB80	ARMORY cymbal arm with Falcon Quick Release, tube diameter 3/4", Chrome Finish	53,63	69,00
MXB80EB	ARMORY Boom arm with Falcon Quick Release, tube diameter 3/4", Black Finish	58,30	75,00
MXB60	MARS boom cymbal arm, tube diameter 3/4", Chrome Finish	30,31	39,00
MXB60EB	MARS boom arm, tube diameter 3/4", Black Finish	34,98	45,00
MXCH72	Closed HiHat for mounting with multi clamps or on a rack, Chrome Finish	84,73	109,00

Tom Holder



Order-No.	Description	Dealer Net €	SRP €
MXMSSTC	SONIClear Single Tom clamp, Chrome Finish	37,31	48,00
MXMSSTCEB	SONIClear Single Tom clamp, Black Finish	38,09	49,00
MXMSSTCBC	SONIClear Single Tom clamp, Black Chrome Finish	43,53	56,00
MXTH653	Single tom holder, steplessly adjustable, 7/8" tube, Chrome Finish	66,07	85,00
MXTH692	Double tom holder for Saturn IV series, 1" tube, Chrome Finish	123,59	159,00
MXTH692B	Double tom holder for Saturn IV series, 1" tube, Black Chrome Finish	185,78	239,00
MXTH676	Double tom holder for Armory, Mars series, steplessly adjustable, 1" tube, Chrome Finish	120,48	155,00
MXTH676EB	Double tom holder for Armory, Mars series, steplessly adjustable, 1" tube, Black Finish	131,36	169,00
MXTH656	Double tom holder for Storm series, steplessly adjustable, 1" tube, Chrome Finish	92,50	119,00

Tom Holder Systems for Saturn IV & V



Order-No.	Description	Dealer Net €	SRP €
MXTHBM2016A	Double Tom holder TH692 and BD Mount Assembly 20x16", Chrome	193,55	249,00
MXTHBM2016B	Double Tom holder TH692 and BD Mount Assembly 20x16", Black Chrome	286,82	369,00
MXTHBM2018A	Double Tom holder TH692 and BD Mount Assembly 20x18", Chrome	193,55	249,00
MXTHBM2018B	Double Tom holder TH692 and BD Mount Assembly 20x18", Black Chrome	286,82	369,00
MXTHBM2216A	Double Tom holder TH692 and BD Mount Assembly 22x16", Chrome	193,55	249,00
MXTHBM2216B	Double Tom holder TH692 and BD Mount Assembly 22x16", Black Chrome	286,82	369,00
MXTHBM2218A	Double Tom holder TH692 and BD Mount Assembly 22x18", Chrome	193,55	249,00
MXTHBM2218B	Double Tom holder TH692 and BD Mount Assembly 22x18", Black Chrome	286,82	369,00



MXMC902



MXMC903



MXMTH908



MXMBL909

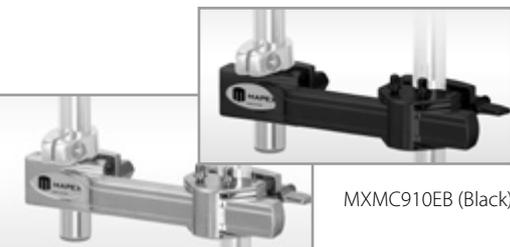

MXMC910 (Aluminium)



MXMCH912



MXMCH913



MX6705-075A

Multi-Clamps & Adapters

Order-No.	Description	Dealer Net €	SRP €
MXMC902	Multi-clamp , Dual-Angle Adjustable	27,21	35,00
MXMC903	Multi-clamp long, Dual-Angle Adjustable	30,31	39,00
MXMTH908	Multi-clamp for two cymbal/tom holding arms	27,21	35,00
MXMBL909	Lifter for 18" and 20" Bass Drum	17,10	22,00
MXMC910	Multi-clamp, extendible in length	20,21	26,00
MXMC910EB	Multi-clamp, extendible in length, Black	22,54	29,00
MXMCH912	Multi-clamp for attaching a cowbell/accessories to the Bass Drum	15,55	20,00
MXMCH913	Multi-clamp for attaching a cowbell/accessories to the stand	28,76	37,00
MX6705-075A	adapter for mounting a TH684 on the BD Mount	13,21	17,00

Accessories

Tuning Key



Order-No.	Description	Dealer Net €	SRP €
MPKZWA059	Drum Key, Chrome	1,55	2,00

Sonic Saver Hoops



MP471410

Order-No.	Description	Dealer Net €	SRP €
MP471308	13" Drum hoop Chrome	45,86	59,00
MP4713081	13" Drum hoop Chrome, Snare Side	45,86	59,00
MP471308BB	13" Drum hoop Black Brushed	69,18	89,00
MP4713081BB	13" Drum hoop Black Brushed, Snare Side	69,18	89,00
MP471410	14" Drum hoop Chrome	50,52	65,00
MP4714101	14" Drum hoop Chrome, Snare Side	50,52	65,00
MP471410BB	14" Drum hoop Black Brushed	76,95	99,00
MP4714101BB	14" Drum hoop Black Brushed, Snare Side	76,95	99,00
MP471410AB	14" Drum hoop Brass Brushed	76,95	99,00
MP4714101AB	14" Drum hoop Brass Brushed, Snare Side	76,95	99,00



MPACDD



MXMBW10



MPACSD



MXMBW20



MPACCBP



MP4680-515A

Pedals Accessories

Order-No.	Description	Dealer Net €	SRP €
MPACDD	Direct Drive for PF1000, PF1000TW	58,30	75,00
MPACSD	Strap Drive for PF1000, PF1000TW	14,77	19,00
MPACCBP	FALCON Beater incl. weights (10g, 20g)	27,21	35,00
MXMBW10	FALCON Beater Weight 10g	5,44	7,00
MXMBW20	FALCON Beater Weight 20g	5,44	7,00
MP4680-515A	Tri-Tonal Beater (maple, felt, plastic)	7,00	9,00



MPACCHC



MPACCHN



MP2680-346A

HiHat Accessories

Order-No.	Description	Dealer Net €	SRP €
MPACCHC	Clutch with Quick Release for all common HiHat machines	19,43	25,00
MPACCHN	Quick Release for all common HiHat Clutches	11,66	15,00
MP2680-346A	Clutch for H950A, H750A, H550A and H350A	11,66	15,00



MPB1000618A



MP3481-355X



MP3480-355X

Cymbal & Boom Stand Accessories

Order-No.	Description	Dealer Net €	SRP €
MPB1000618A	Quick Release cymbal holder M8 for all common cymbal stands	3,89	5,00
MP3481-355X	Multi Sustain Cymbal Felt	3,11	4,00
MP3480-355X	Rubbers Cymbal Felts	2,33	3,00

Snare Drum Wires



MP1S584850A



MP1S582850

Order-No.	Description	Dealer Net €	SRP €
MP1S584850A	for 10" snares, 16 wires, Chrome, Stainless Steel	15,55	20,00
MP1S582850	for 10" Snares, 16 wires, Chrome	7,77	10,00
MP1A396850A	for 12" Snares, 20 wires, Chrome, Stainless Steel	15,55	20,00
MP1A394850	for 12" Snares, 20 wires, Chrome	7,77	10,00
MP1K396850A	for 13" Snares, 20 wires, Chrome, Stainless Steel	15,55	20,00
MP1K394850	for 13" Snares, 20 wires, Chrome	7,77	10,00
MP18796850A	for 14" Snares, 20 wires, Chrome, Stainless Steel	15,55	20,00
MP18794850	for 14" Snares, 20 wires, Chrome	7,77	10,00
MP1F6W0850	for 13" Snares, 42 wires, Chrome	17,10	22,00
MP187W0850	for 14" Snares, 42 wires, Chrome	14,77	19,00

Gigbags

Sets



Gigbag Set for Shellsets –
different configurations

Order-No.	Description	Dealer Net €	SRP €
MXDBS504S	MAPEX bags, Gigbag set for Shellset, 20x18" / 10x9" / 12x10" / 14x14" / 14x5.5"	100,27	129,00
MXDBS522S	MAPEX bags, Gigbag Set for Shellset, 22x18" / 10x8" / 12x9" / 14x11" / 14x5.5"	100,27	129,00
MXDBS524S	MAPEX bags, Gigbag Set for Shellset, 22x18" / 10x8" / 12x9" / 14x14" / 14x5.5"	100,27	129,00
MXDBS628S	MAPEX bags, Gigbag Set for Shellset, 22x18" / 10x8" / 12x9" / 14x14" / 16x16" / 14x5.5"	131,36	169,00
MXDBS529S	MAPEX bags, Gigbag Set for Shellset, 22x18" / 10x8" / 12x9" / 16x16" / 14x5.5"	112,71	145,00
MXDBS525S	MAPEX bags, Gigbag Set for Shellset, 22x18" / 12x9" / 13x10" / 16x16" / 14x5.5"	112,71	145,00

Single Drums

Order-No.	Description	Dealer Net €	SRP €
MXDB808	MAPEX bag, Gigbag for Tom Tom 8x8"	13,21	17,00
MXDB108	MAPEX bag, Gigbag for Tom Tom 10x8"	13,21	17,00
MXDB120	MAPEX bag, Gigbag for Tom Tom 12x10"	16,32	21,00
MXDB131	MAPEX bag, Gigbag for Tom Tom 13x10"	16,32	21,00
MXDB141	MAPEX bag, Gigbag for Tom Tom 14x10"	16,32	21,00
MXDB144	MAPEX bag, Gigbag for Floor Tom 14x14"	27,21	35,00
MXDB1455	MAPEX bag, Gigbag for Snare 14x5.5"	17,88	23,00
MXDB166	MAPEX bag, Gigbag for Floor Tom 16x16"	27,21	35,00
MXDB186	MAPEX bag, Gigbag for Floor Tom or Bass Drum 18x16"	27,21	35,00
MXDB206	MAPEX bag, Gigbag for Bass Drum 20x16"	36,53	47,00
MXDB228	MAPEX bag, Gigbag for Bass Drum 22x18"	36,53	47,00
MXDB220	MAPEX bag, Gigbag for Bass Drum 22x20"	36,53	47,00
MXDB242	MAPEX bag, Gigbag for Bass Drum 24x20"	36,53	47,00

Cymbals / Sticks / Hardware



MXPMKM116



MXPMKM117



MXPMKM113

Order-No.	Description	Dealer Net €	SRP €
MXPMKM113	for hardware, black with logo and wheels	97,16	125,00
MXPMKM116	Cymbal bag black with logo	58,30	75,00
MXPMKM117	Stickbag black with logo and shoulder belt	17,10	22,00



MP0318618MN -
MP0318624MN



MPFHSVTE20W -
MPFHSVTE24W



MPFHAR20W -
MPFHAR22W



Drumheads

Order-No.	Description	Dealer Net €	SRP €
MP0318618MN	18" MAPEX front head Remo Weatherking Powerstroke 3 black, with logo silver	69,18	89,00
MP0318620MN	20" MAPEX front head Remo Weatherking Powerstroke 3 black, with logo silver	69,18	89,00
MP0318622MN	22" MAPEX front head Remo Weatherking Powerstroke 3 black, with logo silver	69,18	89,00
MP0318624MN	24" MAPEX front head Remo Weatherking Powerstroke 3 black, with logo silver	69,18	89,00
MPFHSVTE20W	20" MAPEX front head Remo Weatherking Powerstroke 3 white coated, with Logo black	53,63	69,00
MPFHSVTE22W	22" MAPEX front head Remo Weatherking Powerstroke 3 white coated, with Logo black	61,41	79,00
MPFHSVTE24W	24" MAPEX front head Remo Weatherking Powerstroke 3 white coated, with Logo black	66,07	85,00
MPFHAR20W	20" MAPEX front head Remo UC Powerstroke 3 white coated, with Logo black	24,87	32,00
MPFHAR22W	22" MAPEX front head Remo UC Powerstroke 3 white coated, with Logo black	24,87	32,00

Bassdrum Sticker

KTMXSTBDWH



KTMXSTBDBL

Order-No.	Description	Dealer Net €	SRP €
KTMXSTBDBL	MAPEX Bassdrum Sticker black - plotted, for light background	4,66	6,00
KTMXSTBDWH	MAPEX Bassdrum sticker white - plotted, for dark background	4,66	6,00



Phone +49 6421 989 1550
Fax +49 6421 989 1559



E-Mail
info@musik-meyer-benelux.com



B2B Login

ORDER ONLINE
www.musik-meyer.de/benelux